

Setup & User Guide

SETUP - Wiring and Mounting

iiSmarTorkDemo

www.iiSmarTork.com

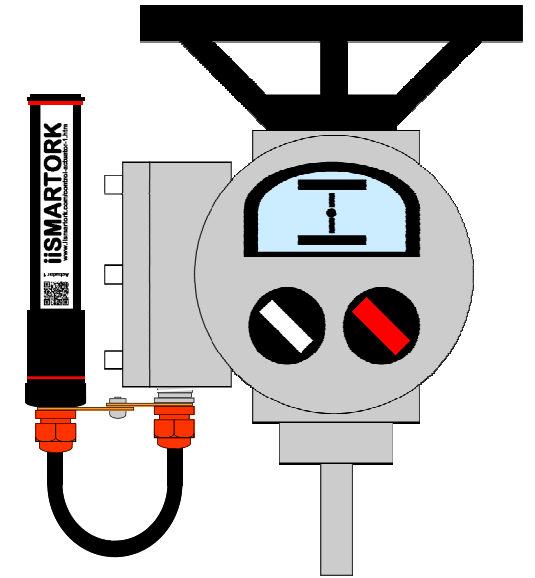
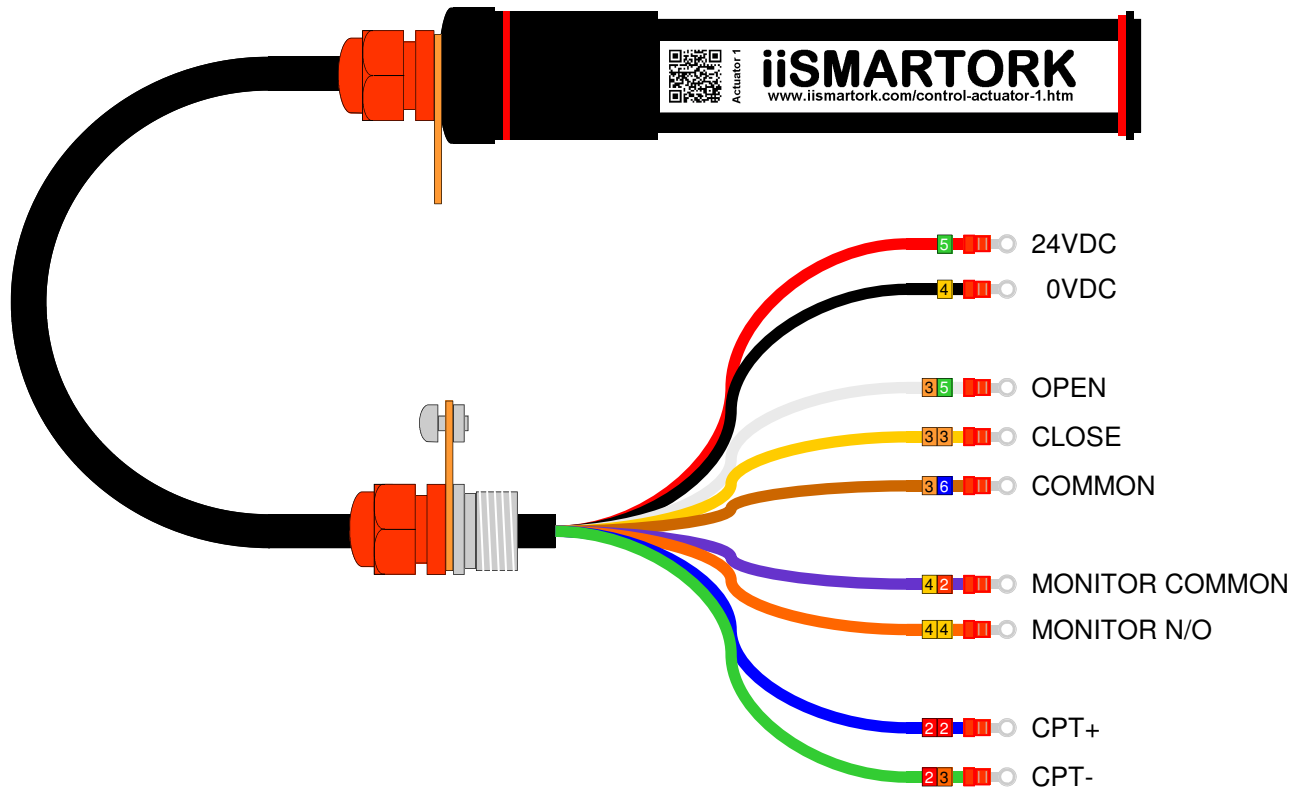

- The iiSmarTork demo loom can be made off at the IQ3 terminal bung via the M25 gland entry.
- The iiSmarTork demo unit can be installed in any orientation using the supplied brackets and fixings.
- The iiSmarTork demo unit is 24vdc powered by the actuators' internal customer supply.

Setup & User Guide

SETUP - Network Connection

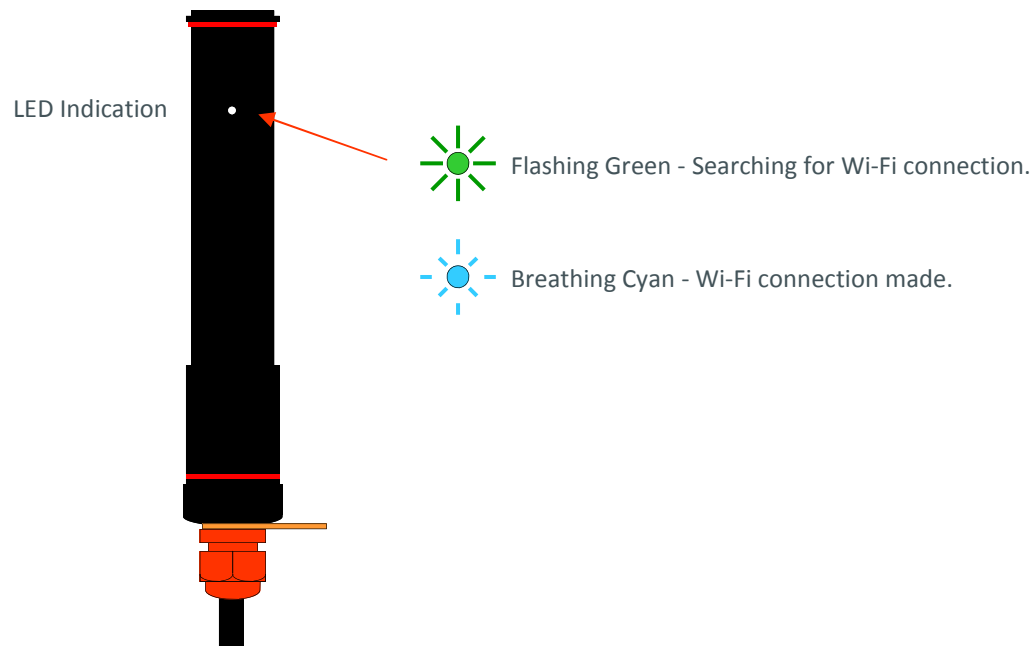
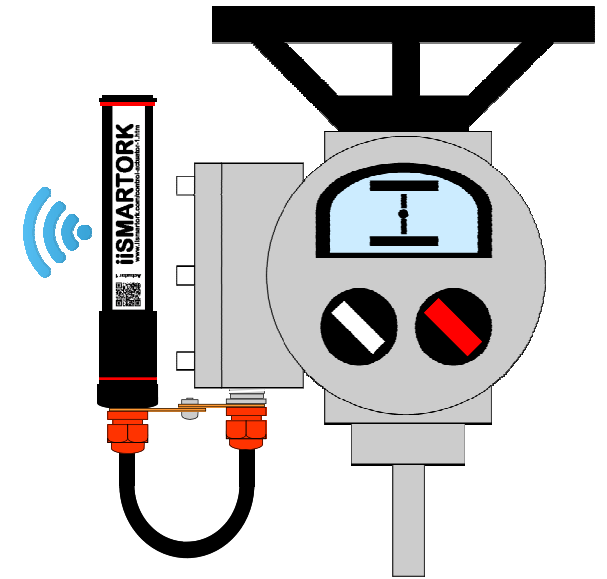
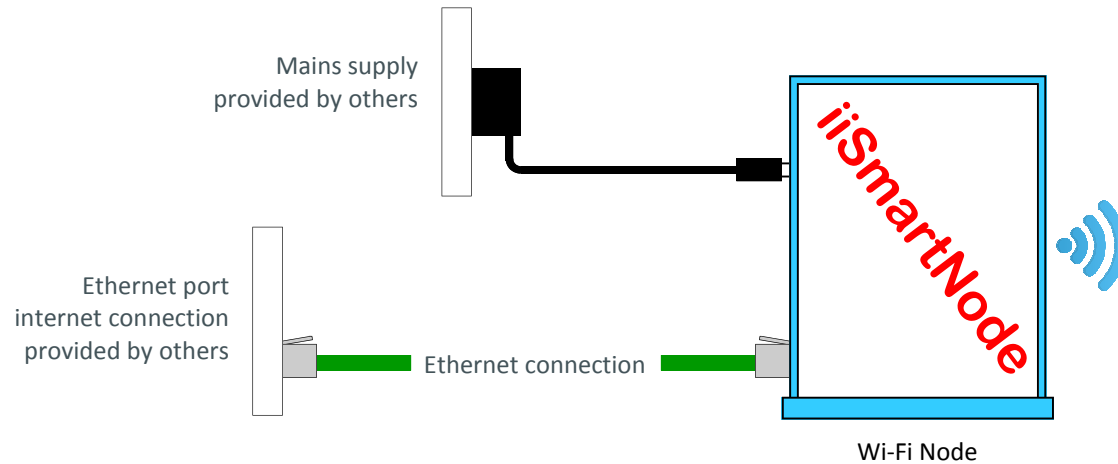

- The iiSmartNode provides the Wi-Fi internet connection which allows the iiSmarTork demo unit to be read and controlled via an internet connected browser.
- The iiSmarTork demo unit will display the current network connection status via an RGB LED at the back of the unit.

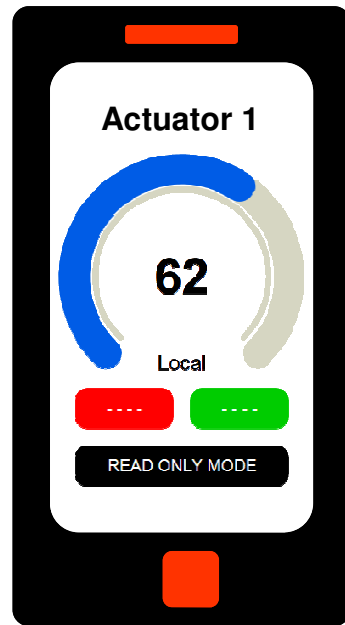
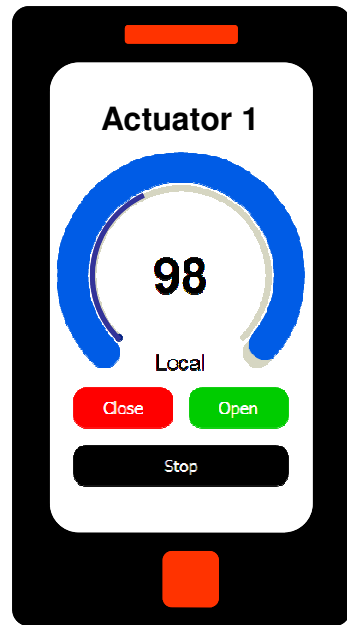

Scan the QR code at the actuator or type www.iiSMARTORK.com into your browsers address bar.

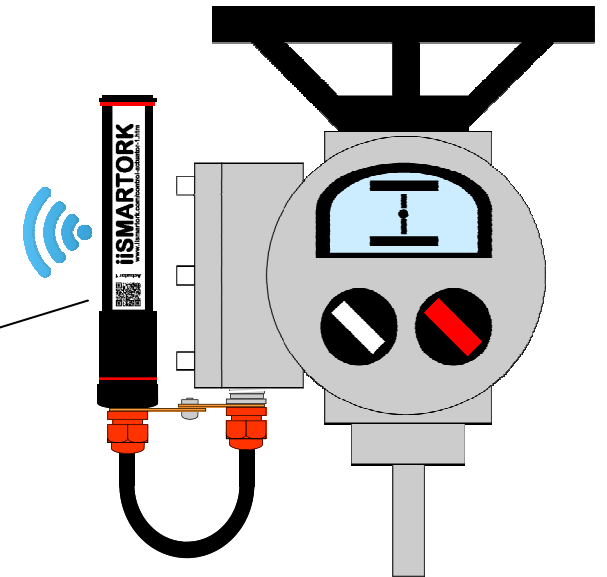

- After accessing the selected actuator you will have approximately 10 minutes to Control & Monitor the actuator. After 10 minutes you will enter Read Only Mode until you select the actuator again.
- Close & Open Buttons run the actuator fully closed or fully open.
- Stop Button will stop the actuator at the current position.
- The Inner Dial moves the actuator to a set position chosen by you.
- The Outer Dial displays the Actuator Position.
- The Monitor Relay Status is displayed as Local or Remote dependant on the status of actuator.



- The iiSmarTork actuator can be directly monitored and controlled by scanning the QR code at the actuator with a mobile device.
- Scan the QR code between 20cm to 30cm away dependant on mobile device.
- Alternatively directly type, www.iiSMARTORK.com into your device and select the appropriate device selector button Link.

- **Alternative connection methods.** Using a mobile phone in Internet sharing mode, create a Wi-Fi HotSpot with a SSID: **iiSmart** and Password: **iismartkey**. Your device will now act as an internet gateway allowing you to control and monitoring the iiSmarTork demo unit. Users note, be aware of your data tariff. This method of connection is to be used only as a last resort.
- **Limitations of demonstration.** In order to make demonstration as simple as possible there are no login or security passwords required. Anybody with an internet connection and browser links can monitor and control the connected actuators. Multiple devices can all monitor the actuators at once. More importantly more than one person can control the connected actuators at the same time. In order to minimise this, each actuator control session is limited to 10 minutes before the browser page reverts to Read Only Mode.
- **Limitations of use.** The iiSmarTork Demo Unit is to be used as a Sale Concept demonstration only. These units are not for field use on any live actuator, they are to be used on demonstration actuators in a sales environment at the risk of the users. As this is a sales tool no security protocols have been implemented.

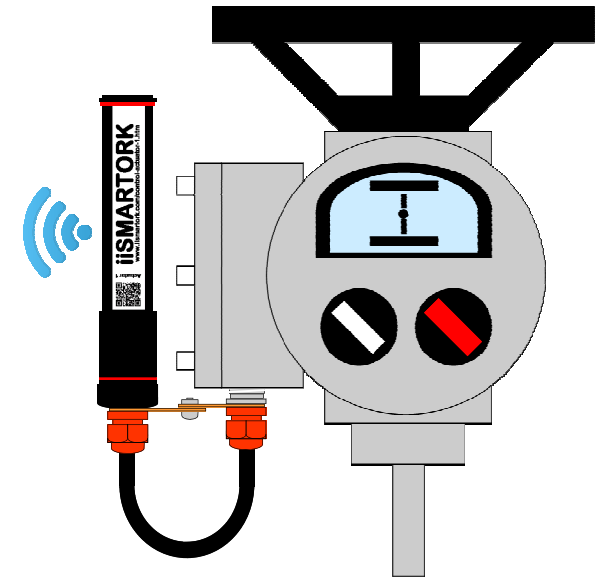

- The iiSmarTork demo unit can communicate directly with a mobile device if the mobile device is setup as a Wi-Fi Hotspot using an internet sharing mode.
- Multiple devices can monitor the connected actuators at once.
- Within the 10 minute control session more than one person at once can control a connected actuator.